

Tooling for Die Casting

SECTION

2

2

Section Contents	NADCA No.	Format	Page
Frequently Asked Questions (FAQ)			2-2
1 Introduction			2-3
2 Types of Die Casting Dies			2-4
2.1 Prototyping			2-4
2.2 Rapid Tooling Dies			2-4
2.3 Production Dies			2-5
2.4 Unit Dies			2-6
2.5 Trim Dies			2-6
3 Casting Features and Die Considerations			2-7
3.1 Core Slide Requirements			2-8
3.2 Parting Line: Cover & Ejector Die Halves			2-8
3.3 Ejector Pins			2-9
3.4 Cast-in Inserts			2-9
4 Die Materials			2-10
4.1 Die and Cavity Materials			2-10
4.2 Die Cavity Insert Materials			2-10
4.3 Die Steel Heat Treatment			2-11
5 Controlling Die Performance			2-11
5.1 Porosity Control: Gating, Venting, Vacuum			2-11
5.2 Thermal Balancing			2-12
5.3 Oil Heating Lines			2-12
5.4 Alternate Surface Textures			2-12
5.5 Extended Die Life			2-12
6 Secondary Machining Preplanning			2-14
7 Gaging Considerations			2-14
8 Inherited Tooling			2-15
9 Engineering Consultation			2-15
10 Database Guidelines			2-16
11 New Die/Inherited Die Specifications			2-16
12 Die Life			2-16
13 Checklist for Die Casting Die Specifications	T-2-1-12	Checklist	2-17
14 Guidelines to Increase Die Life	T-2-2-12	Guideline	2-19

Tooling for Die Casting

A-PARTING LINE

Surface where two die halves come together.

B-LEADER/GUIDE PIN & BUSHING

Guides the two die halves together and maintains die alignment.

C-DIE CAVITY

Die recess in which casting is formed.

D-STATIONARY & MOVING CAVITY INSERT

Premium grade tool steel containing the cavity details.

E-RUNNER & GATES

Precisely designed passage thru which metal flows from sprue hole or cold chamber into die cavity.

F-COLD CHAMBER

Passage thru which metal enters runners and gates.

F1-SPRUE HOLE & SPRUE PIN

Forms passage thru which metal enters runners & gates in a hot chamber die.

G-CORE

Usually a round tapered pin used to cast various hole details.

H-STATIONARY/COVER MOLDBASE

Stationary holder that contains and supports the cover inserts.

I-RETURN PIN

Large ejector pin that resets ejection system.

J-EJECTOR PIN

Pin which pushes casting from die cavity.

K-MOVING/EJECTOR MOLDBASE

Movable holder that contains and supports the ejector inserts.

L-RAILS

Supports the ejector side moldbase and contains clamp slots.

M-RETAINER AND EJECTOR PLATE

Contains and pushes the ejector pins.

N-SUPPORT POST/PILLAR

Additional support members to resist die deflection.

O-GUIDED EJECTION ASSEMBLY (STOP, PIN & BUSHING)

Supports and guides the ejection system.

P-CLAMPING SLOTS

Opening for die clamps to mount die halves to machine platens.

Frequently Asked Questions (FAQ)

- 1) What type of material should be used for die cavity inserts?
See page 2-10, Die Materials
- 2) What is the proper heat treatment procedure for dies?
See page 2-11, Die Steel Heat Treatment
- 3) What is the difference between a Prototype Die and a Rapid Tooled Die?
See pages 2-4, Prototype Dies and 2-5, Rapid Tooled Dies.
- 4) Why are trim dies used?
See page 2-6, Trim Dies.
- 5) What is the difference between a unit die and a self-contained die?
See pages 2-3 through 2-6, Types of Die Casting Dies.
- 6) What types of venting air are possible on a die?
See page 2-11.

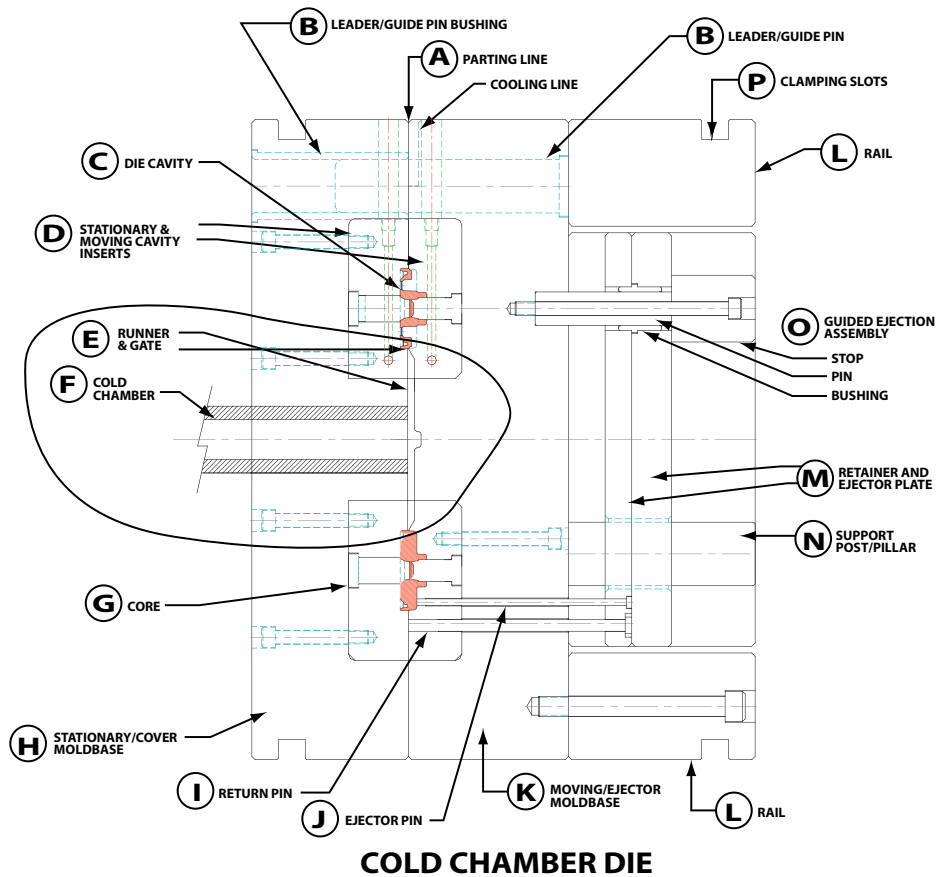

COLD CHAMBER DIE

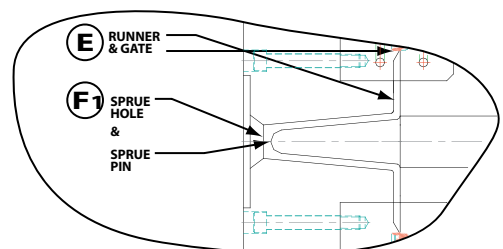

HOT CHAMBER DIE

Figure 2-1 Shown above is a multiple-cavity cold chamber die casting die. With this process the metal enters the die runners, gates and cavity through the cold chamber. The Sprue replaces the cold chamber in the hot chamber process which is used for zinc and smaller magnesium components.

Tooling for Die Casting

1 Introduction

The die casting die, or mold, is a closed vessel into which molten metal is injected under high pressure and temperature, then rapidly cooled until the solidified part is sufficiently rigid to permit ejection from the mold.

For longevity of operation in this environment the die casting die must be built from high-quality tool steel, heat-treated to the required hardness and structure, with dimensions of the die and cavity machined to exacting specifications. The two die halves run in a die casting machine that is operated at the required temperatures and pressures to produce a quality part to net-shape or near-net-shape customer specifications.

The customer's product design requirements directly affect the size, type, features, and cost of the required tooling. The items involved in the tooling decision include the number of cavities, number of core or slide requirements, weight of the die, machining, finish requirements, polishing and plating to name just a few. A convenient checklist of die construction considerations, intended for use in discussion with your custom die caster, appears at the end of this section (page 2-17).

Explanation of the most important terms related to die design are given in the following sections of this chapter. A complete glossary of die casting terms appears at the end of this volume.

The discussion in this section provides a guide to aid the die casting specifier in understanding the requirements of the die caster that will be necessary to produce the optimum die casting, by the most economical production methods.

The various alloys available for die casting, from aluminum to zinc, require unique and special features in the die that produces them. Because of these differences, the descriptions and parameters described in this text are generic. Where possible, options are listed but should be used only as a general guide, with the final decisions discussed between the customer and the die caster.

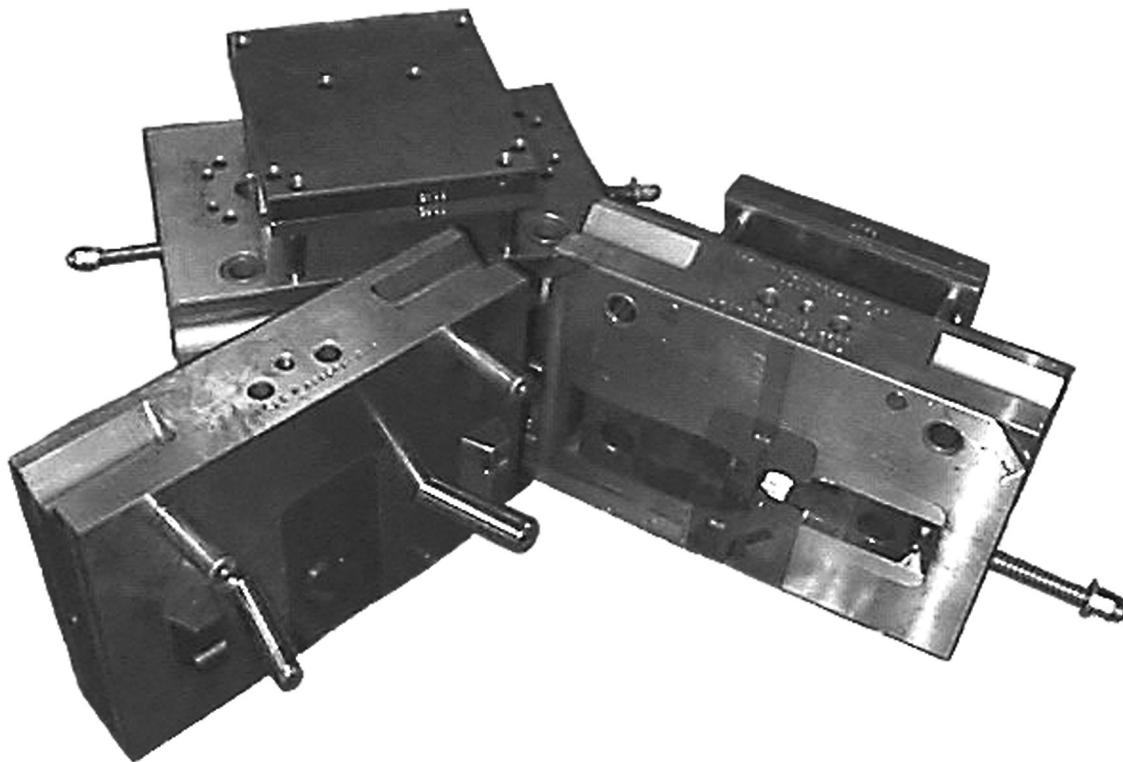

Figure 2-2 A "unit" die casting die, like the one above, allows use of replaceable cavities in standardized main die frames for lower die costs.

Tooling for Die Casting

2 Types of Die Casting Dies

There are various types of die casting dies and each serves a critical need for the customer. The choice of which type of die casting die the customer requires is usually determined by the following:

- *Size of the part to be cast*
- *Volume of parts required*
- *Requirements for “family” sets of parts*
- *Desirability of core slides*
- *Requirements for cast-in inserts.*

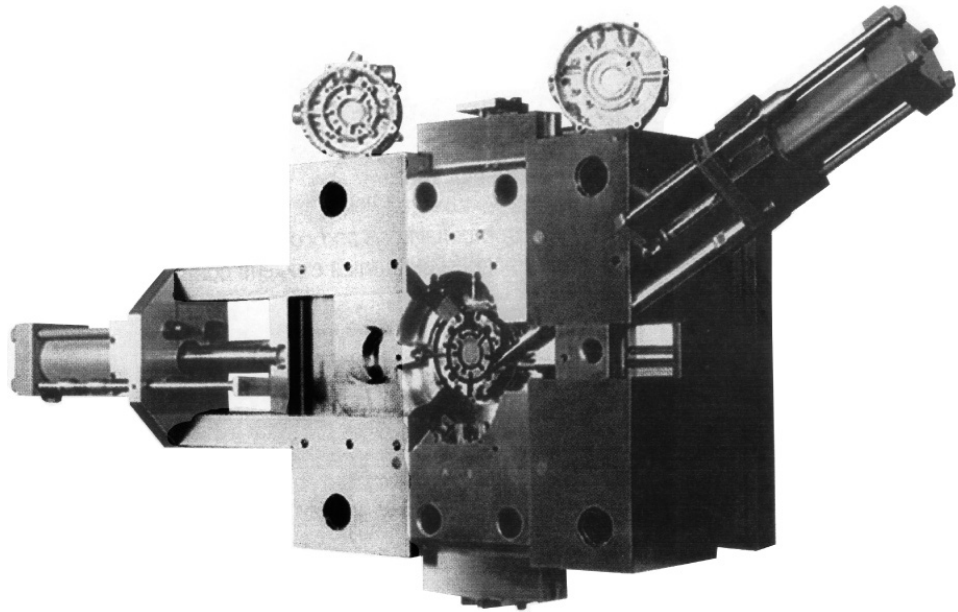

Figure 2-3 This single cavity die uses the moveable die components (slides) to produce complex features in the part shown.

2.1 Prototyping

Prototypes are usually requested by the customer to produce a small number of castings under production conditions. They enable thorough product testing and market exposure before committing to full production dies.

Only production from an actual die casting die can yield a part with precise die cast characteristics. However, there is a range of prototyping strategies that can be employed to approximate a die cast part for eventual production die casting. Among them: gravity casting, including the plaster mold process; machining from previously die cast parts or from wrought and sheet stock; and rapid prototyping techniques such as stereolithography (See the NADCA design manual, *Product Design for Die Casting*.)

2.2 Rapid Tooled Dies

Rapid tooling is a term that refers to dies and inserts produced by methods shorter in lead-time than the conventional method of rough machining, heat treating, and finish machining. Rapid tooling methods include processes such as LENS (Laser Engineered Net Shaping), EBM (Electron Beam Melting), RSP (Rapid Solidification Process), SLS (Selective Laser Sintering), DMD (Direct Metal Deposition), and high speed machining of unhardened steel or pre-hardened tool steel. Investment casting, and KTEL may also be used. Tools produced by these methods may be utilized as prototype or production dies. Production volume requirements may dictate which rapid tooling methods are most viable.

Tooling for Die Casting

2.3 Production Dies

These are the most common types of tools produced. They range from a single-cavity die, with no slides, to a multiple-cavity die with any number of slides. The cavities are made from high-quality tool steel, retained in a quality holder block.

Production dies are built to critical dimensions, coring the maximum amount of stock from the casting, and allowing the agreed-upon amount of machining. A unit die is a special type of production die.

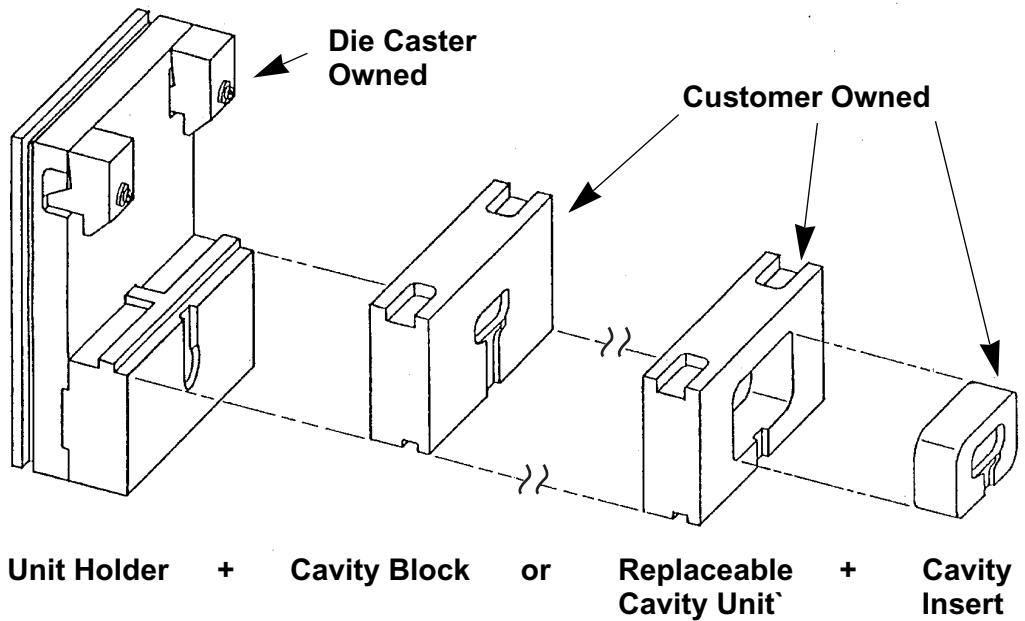
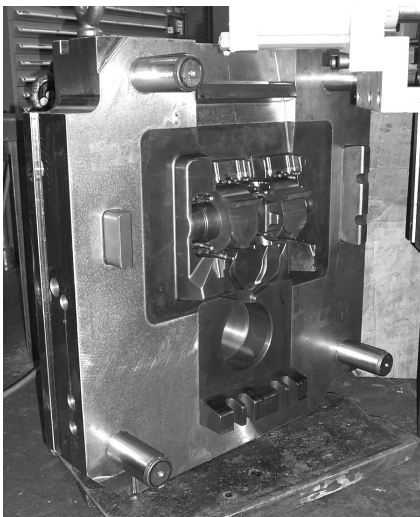
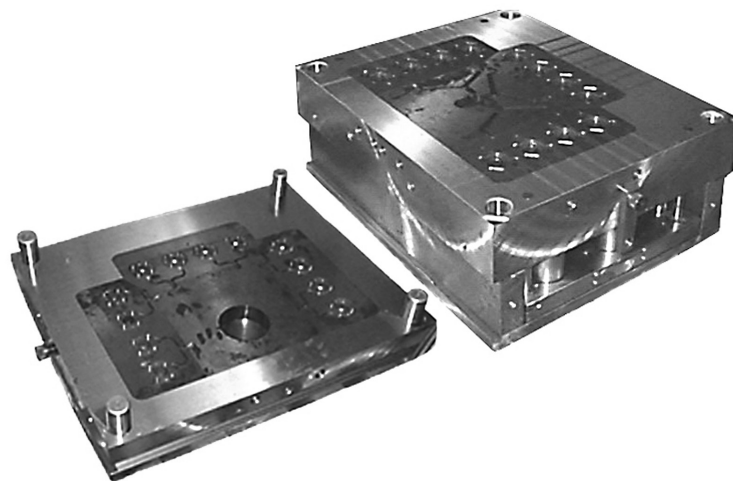

Figure 2-4 Components of a unit die illustrate each part of the assembly and the die construction option of a cavity block or a holder block with cavity insert.



Single-Cavity Die



Multiple-Cavity Die

Tooling for Die Casting

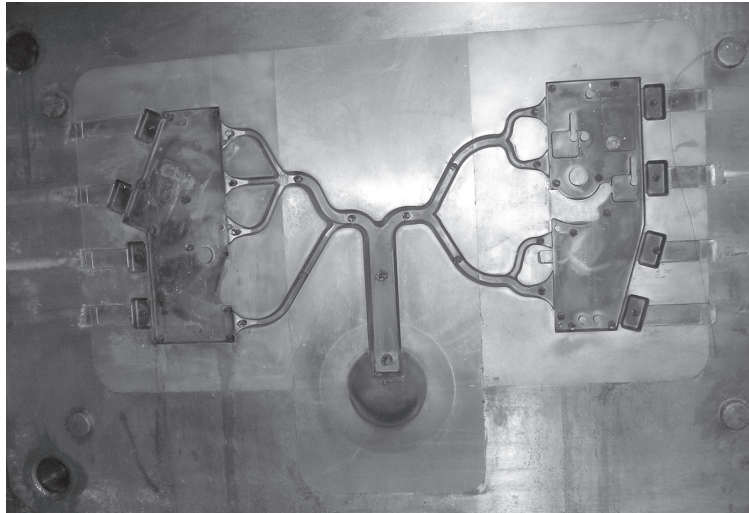

Family Die

2.4 Unit Dies

A unit die is a lower cost production tool that has a standardized main die frame and replaceable cavity units. These replaceable units are designed to be removed from the main die frame without removing the standard frame from the die casting machine.

The most common commercial types of unit dies are single and double unit holders. These types of dies are generally used for smaller parts, or a family of parts, with no slides or a minimum number of slides. Unit dies limit the use of core slides because of the configuration needed for interchangeable unit inserts and the limited space available.

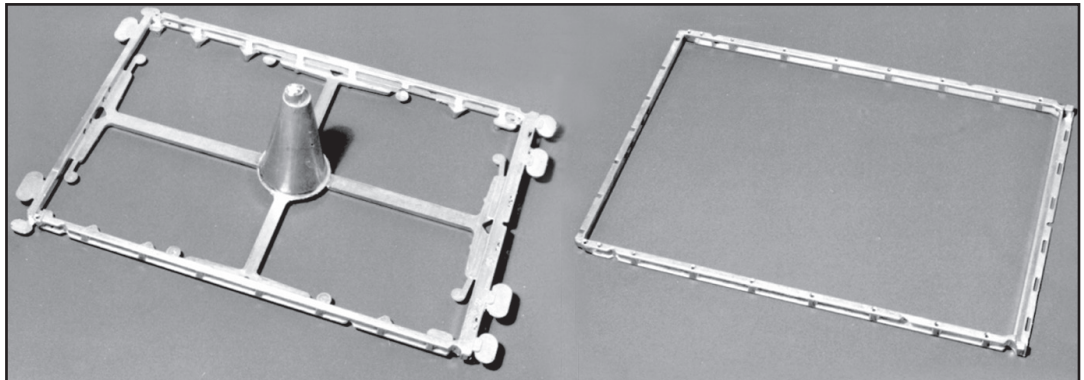

Figure 2-5 Photo on left shows untrimmed zinc die casting as it comes from the die. At right, the same casting after trimming.

2.5 Trim Dies

The trim die is a tool that trims the runner, overflows, and flash from the casting. The trim dies are single or multiple cavity tools, made in the same configuration as the die casting die.

Depending on the shape of the casting, the trim die may be a simple open-and-close trim die or it may include as many slides as the die casting tool. In some cases multiple station trim dies will be used for successive trimming operations.

Trim dies require as much attention to detail in design as the die casting tools and the use of quality materials should be specified to extend their productive life.

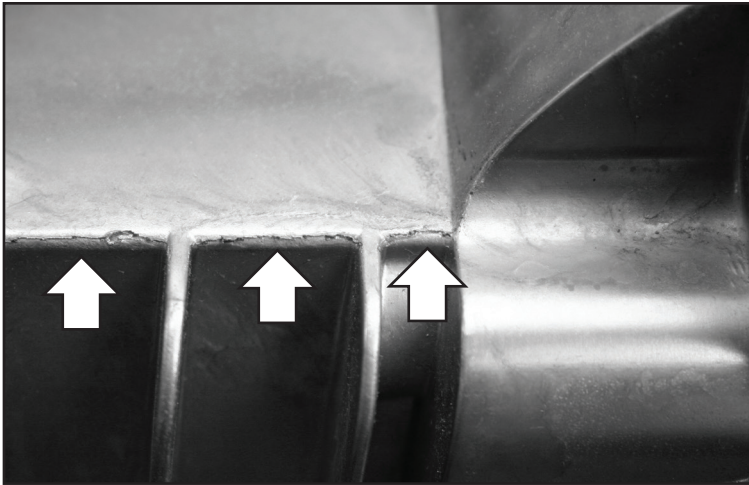

Figure 2-6 Most cracking can be eliminated with larger radii.

3 Casting Features and Die Considerations

The features that are required of a cast part determine the complexity of the die. The simpler the part, the lower the cost of the die casting tool.

The customer should look at the casting in terms of total manufacturing cost. The die caster will aid the customer in examining not only the part design's castability, but also all of the secondary operations that may be required.

Castability and die cost will be determined by answers to the following: Are the wall thicknesses as well as the ribs constant, or do they vary greatly? If bosses exist, do they vary widely in diameter? Will any thin channels on the design create thin standing slivers of steel on the die? Is the part number and other engraving recessed into, rather than raised out of, the casting, making the die more difficult to machine? Are the cored holes that may be called for extremely small in diameter and thus difficult to cast? Is the part designed with sharp corners, promoting stress cracks or with generous radii? See the figure 2-6 and fillet information on page 6-4.

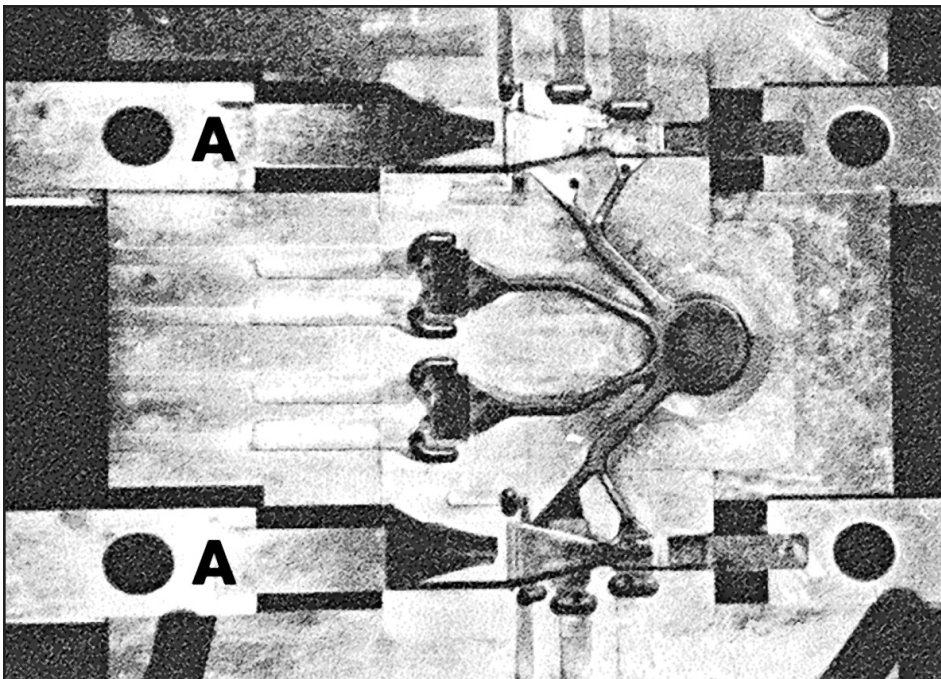

Figure 2-7 This ejector die half shows the two moveable cone-shaped core slides, A, at left which form the interior of the die castings in this two-cavity die. Opposite slides are at the right.

Tooling for Die Casting

For the proper design of production tooling, pressure tightness, secondary machining and surface finishing specifications must be understood in detail. Areas of the casting subject to machining must be fully discussed at the outset, so that the die can be designed to reduce to an absolute minimum the presence of porosity in those areas. Cosmetic surface requirements for the casting will require specific steps in finishing the cavities of the die.

These are among the types of questions that the customer should be prepared to discuss with the die caster while reviewing the supplementary checklist at the end of this section.

The Engineering and Design sections provide detailed treatment of the tolerancing implications of various casting design features, as well as guidelines which apply under differing casting conditions.

3.1 Core Slide Requirements

Fixed cores and core slides (or pulls) can be designed in the die to cast selected features in place, eliminating the need for most – or all – secondary machining of the cast part.

Core slides, similar to collet or cam movements, can be activated by various sources of motion. Two of the most common are angle pins and hydraulic cylinders.

The angle pin is a mechanical source of motion that is activated by the die opening and closing. Its advantages are that it does not require hydraulics or limit switches, and is generally more economical to manufacture. Its limitations are that it can be used only for short slide travel and there is no control over the cycle of the slide pull. It is not recommended for use on top slides. Although the use of springs can make this possible.

The hydraulic method of slide motion permits: a choice of cycles, the placement of slides on the top of the die, and avoids interference when removing the casting from the die (as is the case with the angle pin).

Among the other methods of motion are rack and pinion, ejector lifter, and cam bars. The choice of motion depends on factors such as production volume, size of die, length of travel of slide, size of area being cored out and the configuration of the part. The die caster should be relied upon for the optimum recommendations on core slides, also called moving die components or moving die parts.

3.2 Parting Line: Cover and Ejector Die Halves

The parting line is that perimeter on the casting which is the separation point of the two halves of the die casting die. This line affects which half will be the “cover” die half and which will be the “ejector” half.

This line also influences any tolerances that must be held in this area of the casting. Tolerancing standards specific to part characteristics at the parting line are presented in Engineering and Design, Section 4A.

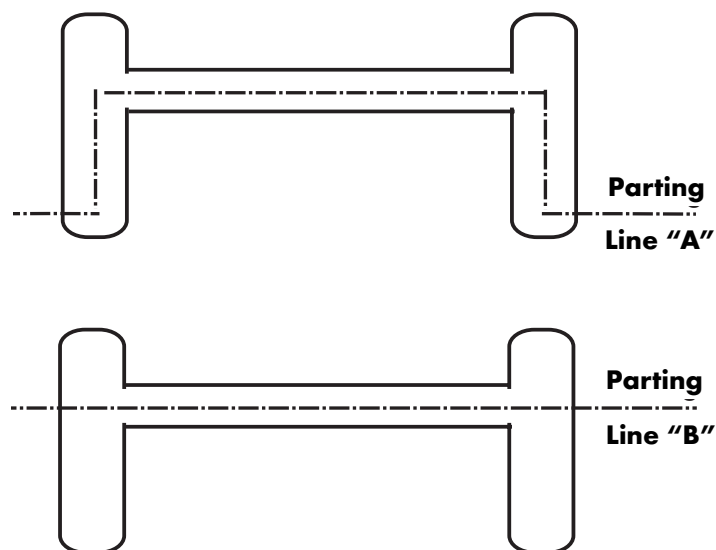

Figure 2-8 Step parting line “A,” originally placed on this casting drawing would not have produced the best production results. The location of the parting line “B” in the bottom drawing will allow better casting fill and cleaner casting trim, plus provide longer die life and a less costly die to build.

Tooling for Die Casting

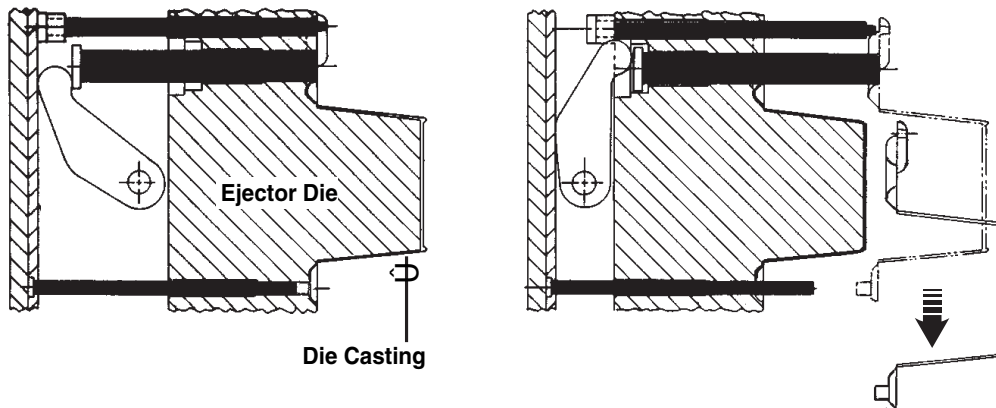

Figure 2-9 Ejector pins, shown in black, are retracted as the metal fills the die cavity (above left); then actuate sequentially to release the casting from the die (above, right).

It is not obvious where the parting line on a casting drawing should be placed. Where the parting line is indicated by the part designer, it is necessary for the die caster to confirm the designer's determination. Agreement on the optimum parting line location is essential for the casting to be produced to the desired specifications.

In the case of a part that must have a cosmetic surface, the cover half will generally be used to produce the cosmetic surface. This permits the ejector half to contain the ejector pins, inserts and any engraving.

If there is no cosmetic surface requirement, the casting can be oriented to suit the most favorable casting conditions. On cosmetic parts, the customer must discuss with the die caster where the gate, overflows and vents will be, to be certain that there is no interference or blemish on the important cosmetic surfaces.

Where there are cosmetic requirements, since normal, incremental die erosion is inherent in the die casting production process, the customer will want to discuss special die maintenance procedures to extend the ability of the die to produce parts with the required high-quality surface finish. Secondary operations to the surface of the part, such as polishing or buffing, should also be discussed to maintain cast part specifications.

3.3 Ejector Pins

Ejector pins are used to push the casting out of the die after the metal shot has been made and casting solidified. The location and size of the ejector pins are dependent on the configuration, size, and other requirements of the casting.

The die caster will always attempt to locate ejector pins in a nonfunctional area of the casting, such as in an overflow, on a boss, in the bottom of a deep pocket, or the bottom of a rib. His recommendations are important as to the size, location and number of ejector pins required for successful part production.

Each ejector pin must be sized to suit the casting configuration in the selected area and will leave a slight impression on the cast surface. For this reason, they are not placed against the cosmetic surface side of the part.

Product standards related to ejector pin locations are discussed in Engineering and Design, Section 6.

3.4 Cast-in Inserts

In some castings, there may be a need for a bearing surface, internal thread, or some other unique feature that could be accommodated by an insert molded into the casting. This requirement can often be met by the die caster within the normal operation of the casting process.

This "insert molding" offers the advantage of firmly setting an insert into the casting so that it can be machined, drilled and tapped. This advantage, however, rarely offsets the added costs of the insert casting operation.

The added costs result from reduced machine cycle time, due to loading the insert into the die and the heating procedure required to heat the inserts before they are placed into the die half. This preheating is recommended to avoid putting moisture into the die, allowing metal to chill around the insert and causing the insert to loosen.

Tooling for Die Casting

Note:

There are many die materials available that vary in both their chemical compositions and mechanical properties. Developments in high speed machining and Wire EDM have led to the use of a wide variety of tool steels based on cavity complexity and position as the material relates to the gate location. Specialty tool steels have their own specific properties but, if used correctly, can increase tool life by up to a factor of two or more. It is also important to note that they usually are more costly as noted in section 4.2. This increased cost can be more than offset by the increase in die life achievable so it is best to consult with the die caster as to what some of the options might be for a given casting design. Specialty tool steels that do not require heat treat or are pre-heat treated before machining have been successfully used in both Prototype and Rapid Tooled Dies for early production starts.

Some of the (but not limited to) manufacturers of these specialty steels are Aubert & Duval, Bohler, CMW, Daido, Dunn Specialty Steel, Elwood Specialty Steel, Kind, Nippon Koshuha, Schmolz & Bickelbach, and Uddeholm. It is best to consult with the die caster as to what some of the tool steel options are for individual casting designs and die construction.

4 Die Materials

The grade of tooling materials to be used in the construction of a die casting die should be specified as high quality, at a minimum, and preferable premium quality. These requirements are based on the extremely high temperatures and pressures used in die casting production.

Tooling grade requirements will vary depending on the tooling component, the alloy being die cast, the critical character of the cast part design and the long-term production quantities desired. Every aspect of the proposed product's design and production specifications must be discussed with the die caster before tooling material can be selected. The following are typical tooling lowest requirements:

4.1 Die and Cavity Materials

- *Die Casting Dies for Zinc Alloys: P-20, H-11, H13, Premium Grade H13 (Per NADCA No. 229), Superior Grade H13 (Per NADCA No. 229), or other grades as defined in NADCA No. 229.*

The zinc alloys, which cast at the lowest temperature in the nonferrous family, cause the least wear on their tooling and thus permit the use of non-premium die material, such as P-20, in cases where part designs are relatively simple. Purchasers are cautioned, however, to be aware of the unwise investment in non-premium grade tooling for zinc parts if there is any possibility that production quantities may reach higher levels than originally anticipated. At higher production levels, such tooling may expire and the cost of replacement dies will far outweigh an original investment in premium material.

- *Die Castings Dies for Aluminum, Magnesium & ZA Alloys (Noncritical part designs, low volume): H-10, H-11, H13.*

Aluminum, magnesium and ZA die casting dies require high quality tool steel, as above. If part designs have very critical features or if high production runs are being contemplated, however, premium grade tooling will always be the wisest investment.

- *Die Casting Dies for Aluminum, Magnesium, ZA-12 & ZA-27 Alloys (Critical part designs, higher volume): Premium Grade H13 (Per NADCA No. 229), Superior Grade H13 (Per NADCA No. 229), or other grades as defined in NADCA No. 229.*

For Al, Mg, ZA-12, and ZA-27 die cast parts, H13 Premium or Superior Grade tool steel is recommended whenever part design features are intricate and specifications tight, and when production volumes will be high. In such cases, non-premium grade tooling will nearly always result in costly premature die failure.

- *Die Casting Dies for Brass Alloys: H13*

Since copper alloy die castings are cast at the highest temperatures of the nonferrous alloys, only H13 high grade tool steel is recommended for brass die casting dies.

Metal certifications for the material grades listed, provided by quality tooling material suppliers, will be made available for inspection by the die caster. The H13 Premium or Superior Grade should meet the NADCA No. 229 tool steel standard (Special Quality Die Steel and Heat Treatment Acceptance Criteria for Die Casting Dies).

4.2 Die Cavity Insert Materials

The materials recommended for use as tool steel for die cavity inserts parallel the recommendations for die cavities, above, with some additions.

In addition to H13 Premium or Superior Grade, the maraging and specialty tool steels* are used for die inserts needing higher hardness to improve their resistance to the heat checking (thermal fatigue cracking) or crazing of the insert's surface caused by thermal cycling of the die from the high temperature molten alloy and die spray/die cooling. The fine cracks that may result can produce corresponding veins on castings.

In high wear (erosion/washout) and temperature areas, especially if internal cooling and/or die spray is difficult, small cores and inserts in aluminum die casting dies can eventually break or wash away due to the velocity of the aluminum entering the cavity. Tungsten- and molybdenum-based alloys are occasionally used successfully in these areas to resist these conditions. Although these materials show superior physical properties compared to conventional steels at high working temperatures, care must be used in machining them. Also, their increased cost must be considered in the overall cost of the die and number of shots required (life of the die).

4.3 Die Steel Heat Treatment

The quality of the heat treatment of the die steel is a very critical step in the tool building process. The use of high quality rapid quenching heat treatment procedures is essential to normal die life. Care must be exercised in the heat treatment procedure to balance the issues of distortion with metallurgical properties that result from rapid quenching. The recommendations of the die caster should be respected.

Just as tool steel source certifications are made available by the die caster, so are the heat treat certifications from the selected heat treatment sources. This documentation will certify that the heat treat was properly carried out to achieve the correct hardness and microstructure.

Tool steel heat treatment should be expected to follow NADCA No. 229 heat treatment guidelines (Recommended Procedures for H13 Tool Steel) and the recommendations of the tool steel manufacturer.

5 Controlling Die Performance

5.1 Porosity Control: Gating, Venting and Vacuum

Although die castings can be expected to exhibit high strength and integrity, some product requirements can call for additional steps in the part design, die design and on-line production stages.

Designers seeking to avoid porosity concerns will be alert to such techniques as eliminating thick wall sections in their designs. (See Product Design for Die Casting for general guidelines). For specific designs, the engineer should always consult with an experienced die caster before design parameters are locked in.

Given the final part design, the die caster will follow specified die design guidelines, and flow simulation (if available), incorporating die gating, overflow and venting configurations to evacuate air properly from the die cavity and reduce porosity to an acceptable level. Where pressure tightness is not a casting specification, the process can be designed so that residual porosity enters only non-functional, internal areas of the casting. Porosity is acceptable in non-critical areas.

While not a substitute for sound product and die design, a vacuum system can also be used to enhance die fill, reduce gas porosity, and improve mechanical properties. A vacuum system is designed to evacuate ambient air from within the die cavity during casting and create a negative pressure or a vacuum. The die must be specially built to accept a vacuum system, so discussions of acceptable porosity levels should be held well in advance of die design.

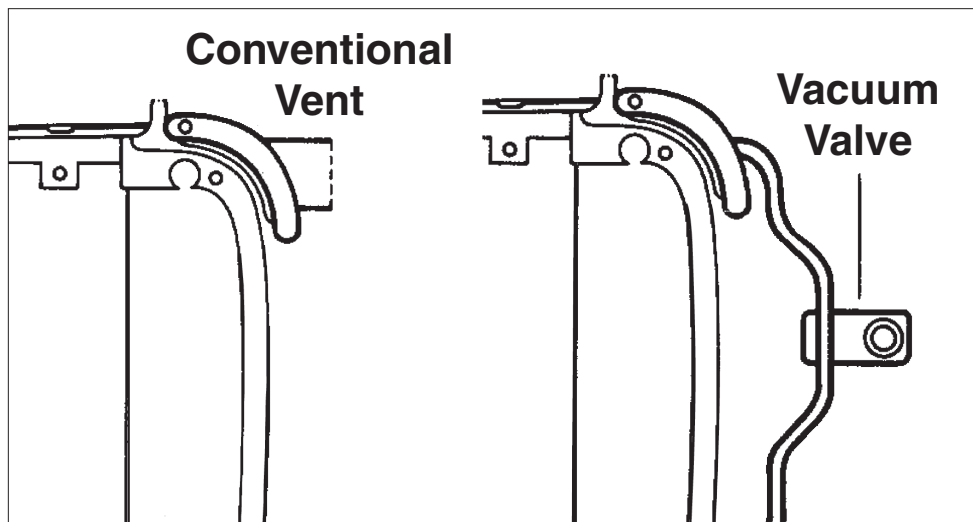

Figure 2-10 Conventional venting in a die casting die, shown at left, vents air to the atmosphere. With a vacuum-equipped die, metal is pulled into a closed system, with air drawn by the vacuum mechanism. A significant reduction in air entrapped in the casting results in lower porosity.

Tooling for Die Casting

5.2 Thermal Balancing

To achieve maximum product quality, the dies are required to run at a precise, specified temperature. This temperature will vary with such factors as the size of the casting, number of die cavities, alloy being cast and machine cycle time.

The alloy is injected into the die at this exact temperature at high speeds and then rapidly cooled for ejection. This extremely fast and repeated cooling requires careful engineering of a complex network of internal die temperature lines. Infrared imaging and thermocouples placed in the die can help measure and maintain correct die temperatures.

Proper thermal balancing through the strategic placement of these lines reduces die casting cycle time, improves casting quality, and lengthens the life of the die.

Different areas of the die can be heated or cooled to different temperatures, i.e., different cover half and ejector half temperatures can be used to aid control of part density or surface finish.

5.3 Oil Heating Lines

In some cases differential heating of various areas of the die to produce specific casting design features will be achieved by the use of hot oil lines in the die.

Hot oil systems heat a special oil to a given elevated temperature and pipe it through the die in the same manner as water cooling lines. Both water cooling and hot oil heating lines may be used.

5.4 Alternate Surface Textures

Using photoengraving techniques in making the die cavities, a wide range of patterns, grainings and textures can be selected for permanent die casting into the surface of a part. The die caster can exhibit actual samples of the common die cast textures possible. (For illustrations of sample textures, see the Surface Treatment chapter of Product Design for Die Castings.)

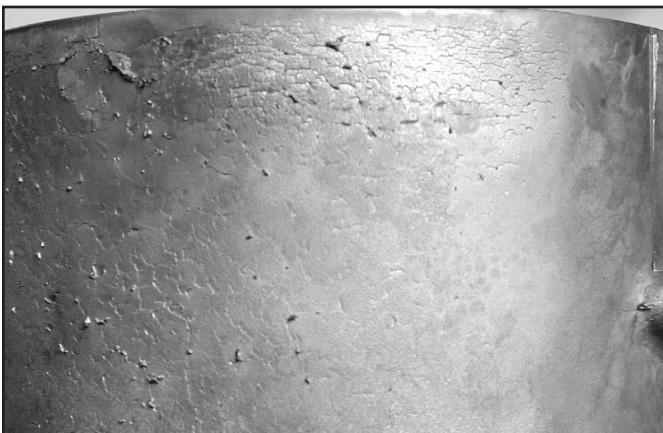

Figure 2-11 Heat checking as seen on a casting.



Figure 2-12 Washout as seen on a casting.

5.5 Extended Die Life

While optimum die life begins with high quality tool steel, several patented processes are available which can be used to extend the life of a die casting die. These processes involve shot peening techniques, submersion in special baths, and chemical treatments of the die. The die caster can discuss the projected effectiveness of such steps to reduce premature die wear in the case of specific part design.

A typical failure mode of dies is heat checking or thermal fatigue cracking.

5.5.1 Heat Checking. Die Casting tools show small cracks (network) as well as bigger (leading) cracks after some time in use, due to thermal fatigue. Both are important to tool life.

The scale in figure 2-13 is designed to give you a combined grading using both network and leading crack values.

Compare the scales with your tool. Give the tool a grading from both scales. Add the two gradings. These two combined readings give you the degree of heat checking.

Tooling for Die Casting

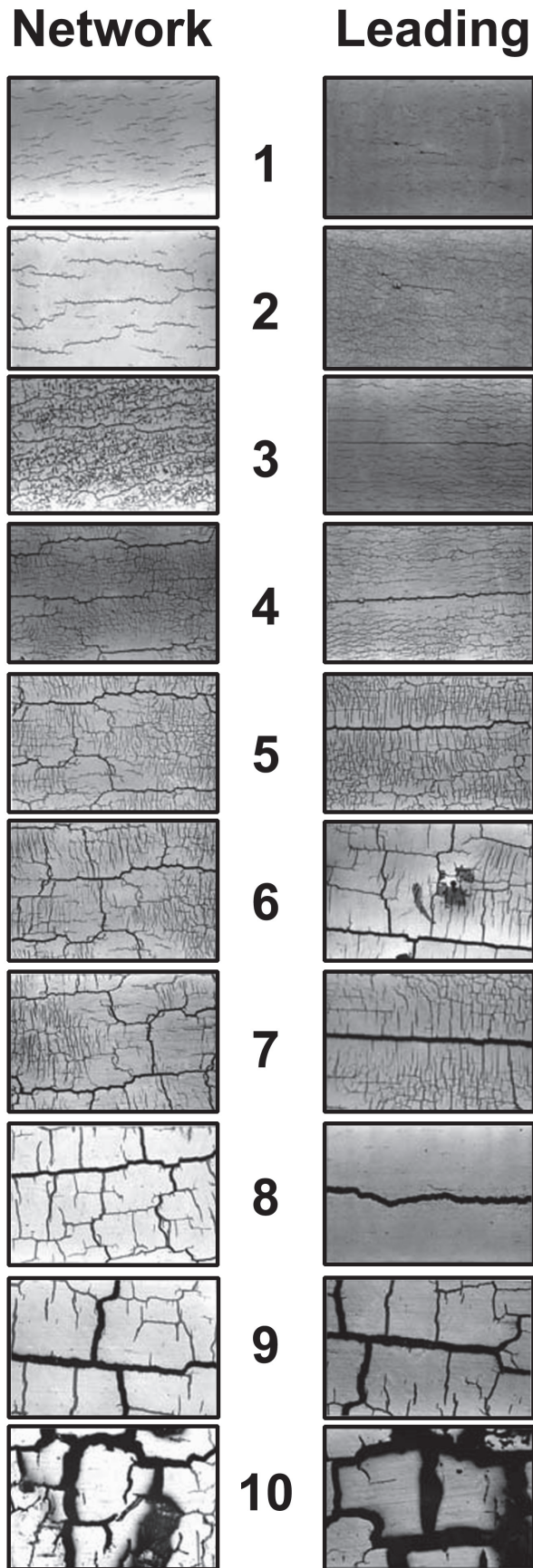

Figure 2-13 Photos of die surface crack patterns reproduced approximately 70% of actual size. The die steel heat check conditions is reflected as raised material on the surface of the casting.

Courtesy of UDDEHOLM

Tooling for Die Casting

Determine at what point the die will no longer be useful. For critical surfaces, such as those to be polished or chrome plated, you might stop using the die at a combined rating of six. For other surfaces, especially those not seen by users of the finished product, the die might be used until the rating is judged to be greater than 14. As the rating goes up, there is not only an aesthetic loss but an economic loss in the production of the parts.

The scale also provides a concrete basis of comparison between different tools and number of shots.

6 Secondary Machining Preplanning

While most die castings are produced to near-net-shape, and many to net-shape, the close tolerances possible with die casting and the repeatability of the process suits die cast parts to economical high-precision secondary machining operations.

A die casting can be designed to accurately adapt to machining fixtures by casting in locator holes or casting a flush locating datum surface. Die castings can be drilled, tapped, reamed, punched, or have nearly any type of machining operation performed on them.

Machining operations, including gaging and any other secondary operations that may be required, can be performed by the die caster. Properly designing the part and the die for optimum quality and economy in secondary machining will have an important impact on reducing final part costs. Detailed discussions should be held with die caster engineering personnel to establish such machining parameters as the precise location, extent, and depth of the machining required; the surface finish required; and any other specification necessary to result in a quality component.

Decisions on special machining equipment ownership, maintenance and replacement must also be discussed. Such matters are outlined in the Commercial Practices section of this manual (page 8-1).

7 Gaging Considerations

What gages will be used in casting production and in secondary machining, and what they will check, are important elements of the die casting program.

Gages may be used to check the casting in its as-cast state and again after machining. The gage may be an attribute gauge, which is basically a “go” or “no-go” check and results in either a good or bad part.

A variable gage may also be employed which, used with a computer, can document variables, collect data, and record Cpk's.

More than one gage may be needed to check a casting: one to check it in its as-cast condition and another to check the casting in a fully machined condition. There may be a need for plug and thread gages as well as finished gages or standards for painted surfaces.

The gaging should be considered by the customer as part of the tooling package. Gaging requirements should be resolved early by the quality assurance managers of both the customer and the die caster, so no questions remain on meeting the part print requirements.

8 Inherited Tooling

In some instances a customer may transfer a die casting die from one die caster to another. This generally will raise some operational questions for the receiving die caster of which the customer should be aware.

The die may need to be put into a different type of die casting machine. This may require some modifications to the die's ejector system as well as to the shot sleeve, i.e. the entry for molten metal.

The die's gate and runner system may also need to be modified to suit the new machine conditions. It may be necessary for any residual oil in the hydraulic system of the die to be sent out for sampling to assure that it does not contain any contaminants.

The die must be evaluated by the customer and the die caster's tool room superintendent to assure that there are no visual problems with the die. They should also determine whether the die arrived with any required limit switches and hydraulic cylinders.

Upon this review an adaptation cost can be established and agreed upon before the receiving die caster has invested a large amount of time and expense in preproduction work.

Checklist T-2-1, at the end of this section, will aid in addressing questions regarding transferred or "inherited" tooling.

Die or tooling ownership and replacement is often a point of discussion. Information regarding this topic can be found in Section 8.

9 Engineering Consultation

The customer company, in the person of its engineering and quality assurance personnel, will usually be requested to meet with the custom die caster's engineering and quality assurance personnel as early as possible to discuss the design and function of the part design proposed for die casting.

They will discuss the design's function, fit and precise assembly with other components.

The die casting process uniquely lends itself to parts consolidation, decreasing the number of components in a product assembly.

Early involvement with the die caster is essential in avoiding expensive corrective steps in later die construction. It can often simplify product assembly and significantly reduce total product costs.

For example, an attached hinge bracket could be die cast as an integral part of the casting. A slight design modification could assure clearance for a close assembly.

The die caster may be able to cast an integral bearing in the part that the customer was planning to press in. Or the die caster may be able to perform a complete or partial assembly operation more economically, such as installing a gasket after painting the casting, and shipping the part ready for assembly. Many die casters have in-house capabilities for operations such as pressure testing, impregnating, machining, surface finishing and subassembly.

The experienced die caster should be regarded as an invaluable source of expertise in the die casting production and assembly process.

Depending on part configuration, very small high-volume zinc parts, weighing fractions of an ounce, may be recommended for production on special hot-chamber zinc die casting machines. Such parts, usually called "miniature" or "microminiature" die castings, can be cast flash-free, with zero draft, to very close net-shape tolerances.

Tooling for Die Casting

10 Database Guidelines

When databases are utilized, quotations for castings are often based on the assumption that any CAD databases provided to build tooling and produce parts are complete, usable and are without need of updating.

Databases may be deemed incomplete and unusable if:

1. *The geometry of the part is not physically moldable.*
2. *The necessary draft and radii are not incorporated.*
3. *Line and surface geometry are not connected within 0.001".*
4. *Parting line is not fully developed.*

Note: The database file format may not be compatible with existing capabilities and may require a translator. STL files are usually only used for creation of prototype parts.

Any necessary database manipulation that is caused by incompleteness as described above could add cost and extended lead-time to tooling.

If databases are designed only to nominal dimensions, tool life and casting tolerances may be adversely impacted.

If solid model databases are used for tool construction, they should be accompanied by a limited dimension part print (either paper or database) that contains all tolerancing information and information pertaining to any secondary machining that is to be performed to the part.

The revision control for databases should be as agreed upon between the die caster and customer.

11 New Die/Inherited Die Specifications

Checklist T-2-1, which follows, will aid in discussions between the customer and the die caster regarding the important considerations in the design of a new die casting die or in the production of parts from "inherited" tooling.

12 Die Life

Die casters are frequently asked the question, "How many shots will I get from the die before it needs to be replaced?" or "How many shots will you guarantee the die for?" A better question might be, "What can we do to maximize die life and to minimize replacement costs?"

Aluminum and Copper die casting dies wear out due to the aggressive nature and high melting temperatures of the materials being die cast.

Die life is a consideration of part design, part function, internal part requirements and part cosmetics. In general, cosmetic areas of the part do not last as long as functional areas.

The following is a suggested approach to be used by the customer and die caster at the time of part design. The intent is to define critical areas of the die casting before the start of tool design. This allows areas to be inserted to maximize die life and minimize the replacement costs.

First, is to develop a rating scale by which this information can be used to relate part considerations to estimated tool life. A guideline (T-2-2) has been developed and includes; a Die Life Checklist, sample part, example of tool steel inserting and identification matrix starting on page 2-19

Tooling for Die Casting

13 Checklist for Die Casting Die Specifications (To be used in consultation with your Die Caster)

Part 1 – New Die Casting Dies: Items to be Addressed

In the case of new die casting dies, all of the items in Part 1, below, should be reviewed. Note, in the case of tooling to be transferred to, or “inherited” by a die caster, the items asterisked (*) in Part 1 should be addressed, plus the items noted in Part 2 on the next page.

Type of New Die	<input type="checkbox"/> Prototype Die Casting Die												
	<input type="checkbox"/> Production Die Casting Die												
Cavity Steel*	<input type="checkbox"/> H13 <input type="checkbox"/> Premium Grade H13 <input type="checkbox"/> Superior Grade H13 <input type="checkbox"/> Other Tool Steel: _____ NADCA No. 229 Certification Required: <input type="checkbox"/> Yes <input type="checkbox"/> No Grade _____ Class _____												
Cavity Steel Heat Treat*	<input type="checkbox"/> Hardness Required: <input type="checkbox"/> Toughness Required: _____ ft.-lbs NADCA No. 229 Certification Required: <input type="checkbox"/> Yes <input type="checkbox"/> No												
Cored Holes*	<input type="checkbox"/> All Holes Cored <input type="checkbox"/> Cored Holes As Noted On Print <input type="checkbox"/> No Cored Holes												
Die Operation for Part Features*	<input type="checkbox"/> Mechanical Movement <input type="checkbox"/> Hydraulic Movement <input type="checkbox"/> Features To Be Achieved By Secondary Operations												
Estimated Part Volume	Monthly: _____ Annual: _____ Expected Product Life: _____												
Casting Alloy*	<table border="0"> <tr> <td></td> <td>Alloy</td> </tr> <tr> <td><input type="checkbox"/></td> <td>Aluminum _____</td> </tr> <tr> <td><input type="checkbox"/></td> <td>Copper _____</td> </tr> <tr> <td><input type="checkbox"/></td> <td>Magnesium _____</td> </tr> <tr> <td><input type="checkbox"/></td> <td>Zinc _____</td> </tr> <tr> <td><input type="checkbox"/></td> <td>ZA _____</td> </tr> </table>		Alloy	<input type="checkbox"/>	Aluminum _____	<input type="checkbox"/>	Copper _____	<input type="checkbox"/>	Magnesium _____	<input type="checkbox"/>	Zinc _____	<input type="checkbox"/>	ZA _____
	Alloy												
<input type="checkbox"/>	Aluminum _____												
<input type="checkbox"/>	Copper _____												
<input type="checkbox"/>	Magnesium _____												
<input type="checkbox"/>	Zinc _____												
<input type="checkbox"/>	ZA _____												
Casting Weight	Estimated Casting Weight: _____												
As-cast Part Finish*	<input type="checkbox"/> Mechanical Grade (Functional Finish) (Ref. 125 Ra) <input type="checkbox"/> Painting Grade (Ref 63 Ra) <input type="checkbox"/> Highest Quality (Cosmetic Finish) For Plating, Etc. (Ref. 32 Ra) <i>*Die wear can affect surface finish over the life of the die.</i>												
Class of Die	<input type="checkbox"/> Unit Die <input type="checkbox"/> Single Cavity <input type="checkbox"/> Conventional Die <input type="checkbox"/> Multiple Cavity <input type="checkbox"/> Multiple Cavity - Family Die												
Cast-In Date Insert*	<input type="checkbox"/> In Die Cavity <input type="checkbox"/> Other Requirements: _____ <input type="checkbox"/> Not Required												
Cast-In Part Number*	<input type="checkbox"/> In Die Cavity <input type="checkbox"/> Other Requirements: _____ <input type="checkbox"/> Not Required												
Other	Write in any other special requirements (ie. tolerances, leak testing, x-rays): _____												

NADCA

T-2-1-15

Checklist

2

This two-part specification checklist is intended for use in consultation with your die caster prior to estimation of new die design and construction, or prior to die casting production using “inherited” tooling. It should be used in combination with checklists C-8-1 and C-8-2 in Commercial Practices, Section 8.

Tooling for Die Casting

NADCA

T-2-1-15

Checklist

This two-part specification checklist is intended for use in consultation with your die caster prior to estimation of new die design and construction, or prior to die casting production using "inherited" tooling. It should be used in combination with checklists C-8-1 and C-8-2 in Commercial Practices, Section 8.

Part 2 — New Die Casting Dies: Items to be Addressed (Continued)

Cast-In Logo, Lettering*	<input type="checkbox"/> In Die Cavity Include: _____	<input type="checkbox"/> Other _____
	<input type="checkbox"/> Customer Logo	<input type="checkbox"/> Cavity No.
	<input type="checkbox"/> Supplier Logo	<input type="checkbox"/> Revision No.
	<input type="checkbox"/> Recycling Logo	<input type="checkbox"/> Part Number
Die Layout	<input type="checkbox"/> Customer to Approve Layout	
	<input type="checkbox"/> Approval by Die Caster	
First-Piece Approval	<input type="checkbox"/> Customer Approval Before Production Run Required	
	<input type="checkbox"/> Run on Die Caster Approval	<input type="checkbox"/> PPAP
Gages*	<input type="checkbox"/> Customer to Supply Special Gages	
	<input type="checkbox"/> Die Caster to Supply Special Gages	
Trim Die	<input type="checkbox"/> Mechanical Movement	
	<input type="checkbox"/> Hydraulic Movement	
	<input type="checkbox"/> Features To Be Achieved By Secondary Operations	
Machining Fixtures	<input type="checkbox"/> No Secondary machining required	
	<input type="checkbox"/> Machining required, no special fixtures	
	<input type="checkbox"/> Special machining fixtures required, customer to supply	
	<input type="checkbox"/> Special machining fixtures required, die caster to supply	
Special Items	Special Items to be included in the tooling package: _____ _____	

Part 3 — Inherited Die Casting Dies: Additional Items to be Addressed

In the case of inherited tooling, not the asterisked items (*) in Part 1, plus the items below.

Note that with transferred, or "inherited," tooling for die casting production the existing die casting die, the trim die, and, if required, the secondary machining fixtures, must be available for review and evaluation to determine whether the dies and fixtures are capable of producing to specifications and the extent of maintenance and/or rework required before the onset of production. This would include any adaptations of the die caster's equipment to accommodate production using the inherited dies. Final production estimates will be based on this review.

Inherited Die	<input type="checkbox"/> Die Casting Die Available for Evaluation
	<input type="checkbox"/> Die to be Available for Evaluation (date): _____
Inherited Trim Die	<input type="checkbox"/> Trim Die Not Required
	<input type="checkbox"/> Trim Die Available for Evaluation
	<input type="checkbox"/> Trim Die to be Available for Evaluation (date): _____
Inherited Machining Fixtures	<input type="checkbox"/> Special Machining Fixtures Not Required
	<input type="checkbox"/> Machining Fixtures Available for Evaluation
	<input type="checkbox"/> Machining Fixtures to be Available for Evaluation (date): _____
Actual Casting Weight	Weight of Actual Casting: _____
Size of Die	Size of Casting Die (for equipment limitations): _____
Weight of Die	Weight of Casting Die (for crane limitations): _____
Availability of Die Design	<input type="checkbox"/> Yes
	<input type="checkbox"/> No

Publisher grants permission to reproduce this checklist as part of a die casting Request for Quotation or Production Specification.

Tooling for Die Casting

14 Guidelines to Increase Die Life

Before the start of tooling

- 1) *Redesign of part to reduce or eliminate sharp internal corners or features that will promote early cracking of the tool steel.*
- 2) *Use of special tool steels in areas where high wear is expected (increases tool costs).*
- 3) *Insert area's of cavity blocks for more economical replacement (may increase tool costs) after tool wear has occurred.*
- 4) *Do a surface treatment (shot blasting) to the tool steel to help reduce heat checking and cracking (adds to tool cost). Note: This will add a surface texture to the die cast part.*
- 5) *Add a vibratory, shot blast or deburring operation to the part to help extend tool life (added part cost).*
- 6) *Add a machining operation to remove heat checking and/or cracking in areas that are critical on the part (adds to part cost).*
- 7) *Reclaim the surface hardness, if possible, when it drops from the 40's HRC to the high 30's HRC.*
- 8) *Coatings can be applied to the die surface to reduce wear and soldering.*
- 9) *Use internal cooling instead of die spray to cool the die. Spray is only to be used as a release agent.*

Die Life Checklist

Class	Part Consideration
A	Critical to Function & Cosmetic
B	Cosmetic, No Function
C	Critical to Function
D	Not Critical but Functional
E	No Function
Class	Estimated Die Life/Shots
1	Less than 10,000
2	10,000 to 25,000
3	25,000 to 50,000
4	50,000 to 100,000
5	More than 100,000

Using the above will develop and itemize the areas of concern of a sample part.

NADCA

T-2-2-15

Guideline

2

Tooling for Die Casting

Sample Part

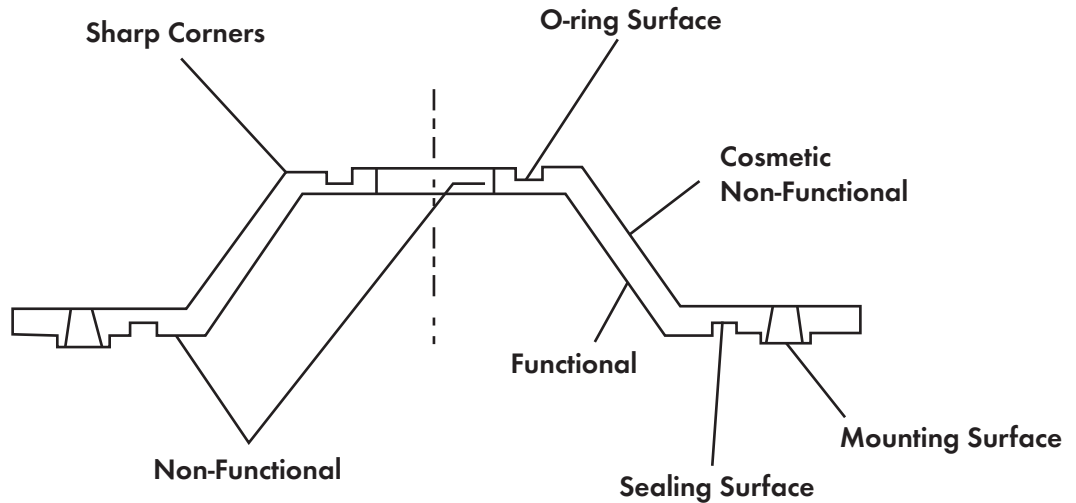

Using the sample, the next step is to develop an inserting plan for the tool steel construction.

Tool Steel Insert Construction

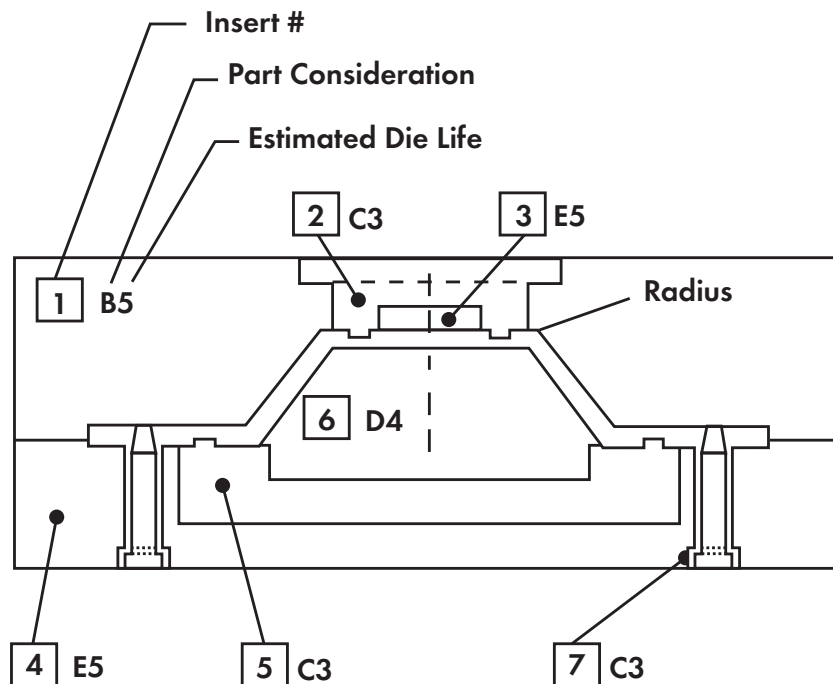

Last is to develop the matrix for communication of tool steel replacement needs and to develop history on each insert. (The information shown in this example represents only what can be done. The actual information to be included should be determined by the customer and the die caster). Two examples of this type of matrix are shown, at the start of a new project and the other as it may appear after the first year of production.

Tooling for Die Casting

Company: Sample Development Co.
 Part Name: Liquid Holder
 Die Caster: ZYX Die Castings Co.
 Annual Usage: 280,000

Part Number: 1234-50
 Tool Number: 6789
 Number of Cavities: 2

Date: xx/xx/xx
 Rev: D

(Matrix at start of new project)

Insert #	Insert Name	Part Class	Est. Life	Cost Each Insert	Lead Time	Actual Shots	Replacement Date/#	Need P.O.	In Progress	On Shelf
1	Cover Cavity	B	5	14,350	10 wks					
2	O-ring Core	C	3	1,185	4 wks					
3	Center Core	E	5	900	3 wks					
4	Ejector Insert	E	5	19,875	12 wks					
5	Seal Insert	C	3	4,150	6 wks					
6	Fluid Insert	D	4	3,210	5 wks					
7	Core Pin Mtg Sur	C	3	185 ea. (8x)	2 wks					

(Matrix after first year of production)

Insert #	Insert Name	Part Class	Est. Life	Cost Each Insert	Lead Time	Actual Shots	Replacement Date/#	Need P.O.	In Progress	On Shelf
1	Cover Cavity	B	5	14,350	10 wks	118000	xx/xx/xx #2		1	0
2	O-ring Core	C	3	1,185	4 wks	32000	xx/xx/xx #4	x	3	1
3	Center Core	E	5	900	3 wks	80000	xx/xx/xx #3		1	0
4	Ejector Insert	E	5	19,875	12 wks	140000	xx/xx/xx #2		1	0
5	Seal Insert	C	3	4,150	6 wks	45000	xx/xx/xx #4	x	2	2
6	Fluid Insert	D	4	3,210	5 wks	96000	xx/xx/xx #2	x	0	0
7	Core Pin Mtg Sur	C	3	185 ea. (8x)	2 wks	40000	xx/xx/xx #3 set	x	0	2 sets

As mentioned earlier this is just a suggested approach to improving die life and reducing replacement costs. Die casting dies do wear out. It is an advantage to both the customer and the die casters benefit to layout a plan at the start of the project. This allows inserts to be replaced before any actual failure thus preventing any possible loss of production. The examples shown are only one of many possible methods to achieve this. If the customer and die caster choose to use this type of approach, it should be on a part by part basis. The information in the matrix should be relevant to the actual tool construction and the actual annual usage.

Tooling for Die Casting