

Engineering & Design: Additional Specification Guidelines

SECTION

6

Section Contents	NADCA No.	Format	Page
Frequently Asked Questions (FAQ)			6-2
Introduction			6-2
1 Pressure Tightness	G-6-1-15	Guideline	6-3
2 Fillets	G-6-2-15	Guideline	6-4
3 Ribs and Corners	G-6-3-15	Guideline	6-5
4 Ejector Pins, Pin Marks and Pin Flash	G-6-4-15	Guideline	6-6
5 Metal Extension (Flash) Removal	G-6-5-15	Guideline	6-7
6 Surface Finish, As-Cast	G-6-6-15	Guideline	6-8
7 Die Cast Lettering and Ornamentation	G-6-7-15	Guideline	6-10

Engineering & Design: Additional Specification Guidelines

Pressure-tightness specifications for die castings, to assure containment of liquids or gases in use, require deviations from standard production and inspection practice. Extra steps, including special pressure-testing equipment and testing procedures, are usually needed.

Frequently Asked Questions (FAQ)

- 1) How much flash can be expected to remain on a die casting after degating and trimming?
See page 6-7, Metal Extension (Flash) Removal.
- 2) If lettering is cast into the part, what are the options?
See page 6-10, Die Cast Lettering.
- 3) Are ejector pin marks required on the casting and will they have flash?
See page 6-6, Ejector Pins, Pin Marks and Pin Flash.
- 4) What is a typical pressure tightness that die castings can withstand?
See page 6-3, Pressure Testing.
- 5) What is the best surface condition I can expect on die cast surfaces?
See page 6-8, Typical As-Cast Surface Roughness Guide.
- 6) Why add ribs to the casting in-place of thick sections?
See page 6-5, Ribs and Corners.

Introduction

The die casting specifications discussed in this section relate to aspects of die casting design and production for which precise standards are difficult to set forth. As in previous Engineering sections, they replace the former ADCI/NADCA “E” Series.

They include characteristics which are highly dependent on the design and shape of the particular part to be die cast, such as pressure tightness of the finished part; the proper design of fillets, ribs and corners in a part; the consideration of ejector pin locations, pin marks and pin flash; casting flash and its removal; as-cast surface finish specifications; and the casting of lettering, logos and ornamentation on the part surface.

While specifications will vary with the desired characteristic, certain guidelines have been established for die casting production under normal practice which can yield the most economic results.

It is obvious that close consultation with the die caster prior to freezing design decisions is the wisest course to follow.

1 Pressure Tightness in Cast Parts

Assurance of pressure tight castings is highly dependent on the design configuration of the part. Consultation with the caster in the early design stages is essential where a specification for pressure tightness exists, in order to take advantage of basic product design, casting die design, and production processing factors. All of these factors are involved in insuring pressure tightness of the final cast part.

While most cast part designs can be cast pressure tight, specific castings may require impregnation to achieve required pressure tightness.

Special Notification Required

Specifications for pressure tightness will require deviations from standard production and inspection practice. Special pressure testing equipment and testing procedures are usually needed.

The requirement for pressure tightness should be made only where it is essential to the performance of the finished part. Where so specified, test methods and inspection procedures should be agreed upon in advance between the customer and the caster. Duplicate test fixtures and test methods are recommended wherever possible.

The discussion of “Porosity” and “Pressure Tightness” under Quality Assurance, Section 7 of this manual, should be reviewed.

Engineering & Design: Additional Specification Guidelines

NADCA

G-6-1-15

GUIDELINES

Guidelines for Pressure Tightness

Important considerations relating to the economical production of pressure-tight castings include the following guidelines:

1. Product Design and Die Design

Successful casting of pressure-tight castings require close conformance to the principles of good casting product design.

- a. *Guidelines concerning fillets, ribs and corners (G-6-2 and G-6-3), in this section, should be followed very carefully.*
- b. *Part wall sections should be of uniform thickness as much as possible.*
- c. *Holes and passages requiring pressure tightness should be cored to reduce porosity, as opposed to machined after casting.*
- d. *Ample draft should be provided in all cored holes and passages which are not to be machined. Cored holes which are to be machined should be given minimum draft (see Draft Tolerances pg. 4A-21).*
- e. *Heavy sections, as well as abrupt changes in sectional thickness, should be avoided.*
- f. *Special vacuum casting techniques may be required in addition to special steps in temperature control, the use of squeeze pins and other procedures to achieve final part specifications where the part design does not conform to good casting design guidelines.*

2. Secondary Machining

The nature of the casting process is such that the outer surface of a casting is usually dense. Thus, thinner walls will be largely free of porosity, while thicker walls can be expected to contain some porosity within. Pressure-tight designs must set strict limitations on secondary machining.

- a. *A minimum amount of machining stock should be removed, to avoid exposing porosity by cutting deeply into a casting (see Machining Stock Allowance Tolerances, pg. 4A-40).*
- b. *Large draft angles, which would require the removal of a large amount of stock from a surface to be machined, should be avoided, particularly where holes are cored.*
- c. *Machining both sides of the same section of a pressure-tight casting should be avoided.*
- d. *Where machining can expose porosity, impregnation may be required to insure pressure tightness. (See figure 7-5 in Section 7.)*

3. Die Casting Alloy Selection

Certain alloys are best for producing pressure-tight castings. Refer to the Alloy Data sections for alloy comparisons of pressure-tightness characteristics to aid in the selection of the most favorable alloys.

4. Pressure Testing

Pressure-tightness testing for castings is generally specified in the range of 5 to 40 psi. Higher pressures will require special consideration by the caster and will be almost entirely a function of the part design.

In the case of pressure-tight casting requirements, review inspection procedures in of Commercial Practices, Section 8, and Porosity Control on pg. 2-11.

Pressure-tightness specifications for die castings, to assure containment of liquids or gases in use, require deviations from standard production and inspection practice. Extra steps, including special pressure-testing equipment and testing procedures, are usually needed.

Engineering & Design: Additional Specification Guidelines

These recommendations regarding the design of fillets, ribs and corners represent guidelines which will result in die casting at the most economic level under normal production practice. Sharp inside surface junctions, acute angle corner conditions and delicate, deep and closely spaced ribs should be specified only where and when necessary, since additional costs may be involved.

2 Fillets in Die Cast Parts

Fillets

Intersecting surfaces forming junctions are best joined with fillets to avoid high stress concentrations in both the die castings and the die casting die. This will reduce die maintenance costs and increase the life of the die.

In the sketches below, consideration has been given to the normal stresses on the die cast part in use and to the stresses induced in the die castings by the casting process itself, as well as to other manufacturing and die maintenance considerations.

Fillet Draft

Fillets projected in a direction normal (perpendicular) to the parting line require draft. The amount of draft is always governed by the draft of the intersecting surface, if a constant fillet radius is maintained.

Shallow vs. Deep Die Casting Designs

These suggestions apply to fillets on corners which are projected normal to the parting plane in die castings of moderate depth. Shallow die castings may have much smaller fillets, while deep pockets and other inside corners should have larger fillets.

Avoid Long, Sharp Corners

Long, sharply squared corners projecting in a direction normal to the parting plane may cause spalled edges on the die casting and should be avoided.

Recommended Fillet Designs and Allowances

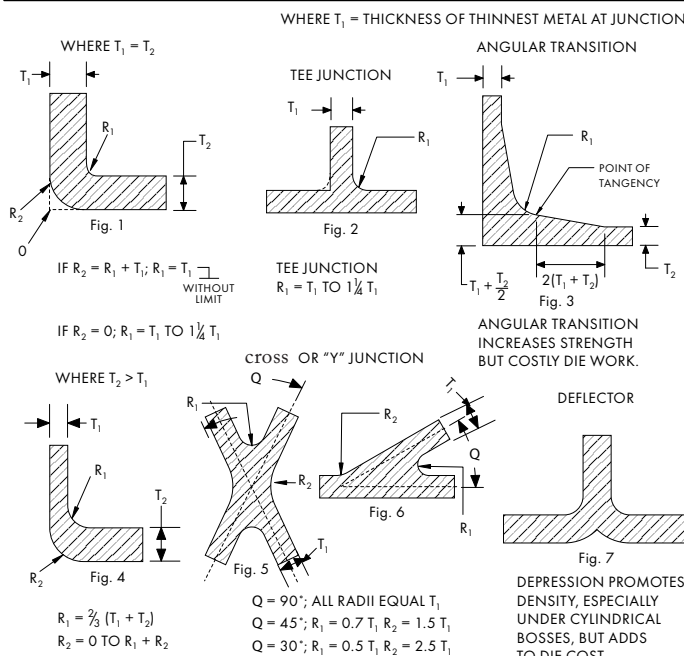

Less Desirable

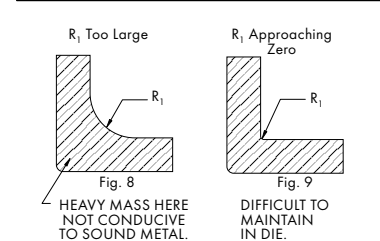

Not Recommended

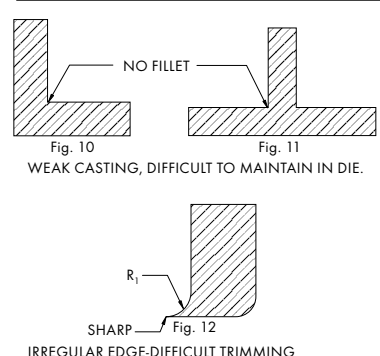

NO FILLETS

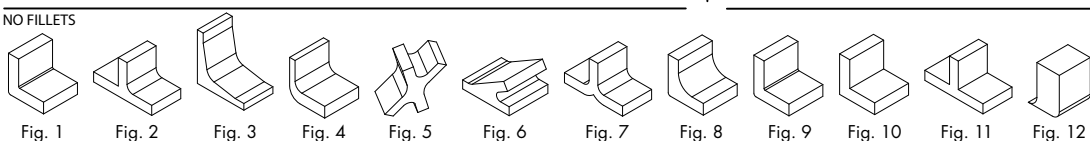

3 Ribs and Corners in Die Cast Parts

Ribs

Ribs are used to increase the stiffness of, or add strength to, a die casting and to aid in making sound die cast parts. Often, ribs add more strength to die castings than solid material due to porosity. Ribs are sometimes misused and can be a detriment if working stresses are concentrated by their use or if high stresses are created at the edges of the ribs by their design.

External Corners

Sharply squared external corners may be used in some locations if die construction permits. This type of corner is mandatory at parting line locations and die block intersections. Elsewhere, corners of die castings should have radii to prevent early die failure, to reduce the probability of nicking the edge of the die casting in handling and assembly, and to minimize material handling hazards for personnel.

Small Metal Savers

Ribs are often an integral part of making a die casting stronger, but a die cast part designer needs to be cognizant of the steel as well. The empty space left in between ribs that serves no functional purpose on the part is called a metal saver. Often, adding ribs close together can result in thin or weak metal savers required in the die cast die to form the rib features in the part. The designer should review the part for:

- Relatively deep metal saver pockets
- Relatively sharp edges to metal saver pockets
- Relatively small draft on the sides of the metal saver pockets

All of the above should be avoided when designing the die cast part. The die caster or tool maker can be consulted for design suggestions as well.

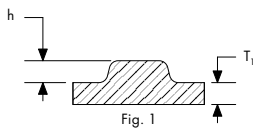
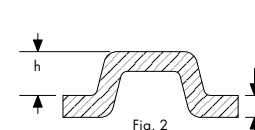
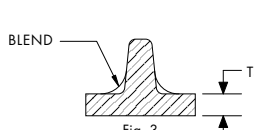
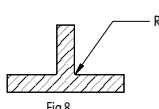
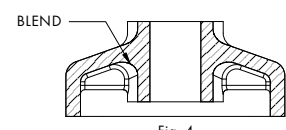
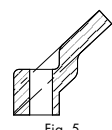
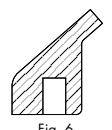
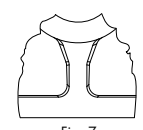
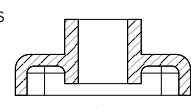
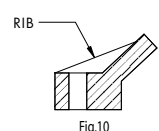
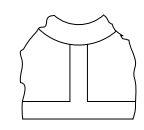
Recommended Rib Designs and Allowances				Not Recommended			
 <p>Fig. 1 $h = T_1$</p>	 <p>Fig. 2 WHERE $h > T_1$ CORE OUT UNDERNEATH TO AVOID UNDESIRABLE HEAVY MASS OF METAL.</p>	 <p>Fig. 3 BLENDING AS SHOWN MAY BE DESIRABLE.</p>	 <p>Fig. 8 SHARP CORNERS – SMALL RADII.</p>				
 <p>Fig. 4 RIBS INSIDE – GOOD DISTRIBUTION OF METAL FOR ALL PURPOSES.</p>	 <p>Fig. 5 GOOD DISTRIBUTION OF STRESSES</p>	 <p>Fig. 6</p>	 <p>Fig. 7 RIB FROM FLANGE TO BOSS – GENEROUS DRAFT AND FILLETS – NOTE ANGULAR TRANSITION.</p>	 <p>Fig. 9 NO RIBBING – BOSS EXTENSIONS LESS DESIRABLE FOR CASTABILITY</p>	 <p>Fig. 10 EXTERNAL RIBS MAY CAUSE POOR DISTRIBUTION OF STRESS</p>		
			 <p>Fig. 11 SHARP CORNERS – SMALL RADII – LITTLE DRAFT</p>				

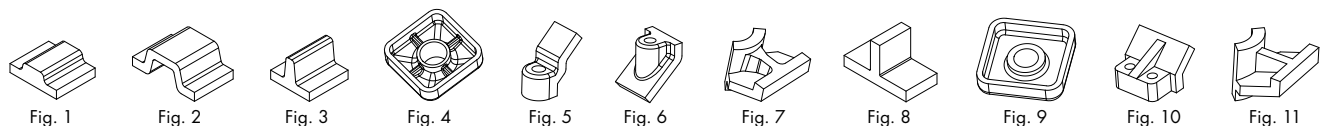

These recommendations regarding the design of fillets, ribs and corners represent guidelines which will result in die casting at the most economic level under normal production practice. Sharp inside surface junctions, acute angle corner conditions and delicate, deep and closely spaced ribs should be specified only where and when necessary, since additional costs may be involved.

Engineering & Design: Additional Specification Guidelines

4 Ejector Pins, Pin Marks and Pin Flash

The guidelines presented here for the location of ejector pins, pin mark tolerances and procedures regarding pin flash represent standard die casting production practice at the most economic level. Disregarding these guidelines should be done only when and where essential to the product design, since additional cost may be involved.

Ejector Pin Marks

Moveable ejector pins must be used to eject a die casting from the die casting die and will result in a residual ejector pin mark on the die cast part.

In addition to automatically pushing the casting from the die after part solidification, ejector pins also serve to keep the casting from bending.

The sequential illustrations at right demonstrate the action of the ejector pins in a die casting cycle.

Location Of Ejector Pins

Ejector pin locations should be at the option of the die caster, subject to the customer's agreement. Where considerations of cast surface cosmetics are important, ejector pin locations should always be discussed in advance of die design.

The number, size and location of ejector pins and bosses required will vary with the size and complexity of the die casting, as well as with other factors.

Acceptable Ejector Pin Marks

Ejector pin marks on most die castings may be raised or depressed .015" (.381 mm). Raised ejector pin marks are preferred for optimum production. Larger castings may require additional ejector pin tolerances for proper casting ejection.

Ejector Pin Operation

With each die casting cycle, the die opens and the ejector plate in the ejector half of the die (Fig. A) automatically moves all ejector pins forward (Fig. B), releasing the casting from the die. Then, the die casting is removed from the die manually or mechanically.

Ejector Pin Flash

Ejector pin marks are surrounded by a flash of metal. Normally, ejector pin flash will not be removed, unless it is objectionable to the end use of the part.

Alternatively, ejector pin flash may be specified as crushed or flattened.

In the case of either nonremoval or crushing/flattening, flash may flake off in use.

Complete removal of ejector pin marks and flash by machining or hand scraping operations should be specified only when requirements justify the added expense.

Bumping Ejector Pins

When ejector pins are placed on a flat surface, it can sometimes cause the side opposite the ejector pin to bulge out on the part (called bumping). Bumping can be minimized by:

- Increasing the wall thickness (increasing locally is an option as well).
- Placing ejector pins near vertical walls (distributes some ejection force to ribs).
- Placing ejector pins on top of ribs.
- Increasing draft.

Ejector Pin Operation

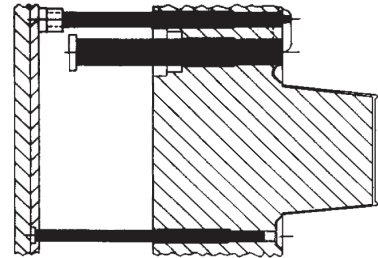

Figure A

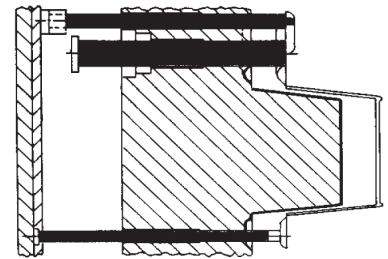

Figure B

Engineering & Design: Additional Specification Guidelines

NADCA

G-6-5-15

GUIDELINES

5 Metal Extension (Flash) Removal

Metal Extension (Flash) Formation and Location

An extension of metal is formed on die castings at the parting line of the two die halves and where moving die components (also called moving die parts) operate (see Figure 6-1).

A seam of metal extension may also be formed where separate die parts cast a part feature. Residual metal extension is also formed by the normal operation of ejector pins and is discussed on the previous page.

Simplifying Extension (Flash) Removal

Necessary casting metal extension removal costs can be reduced by consideration, in the design stages, of the amount of metal extension to be removed and the removal method to be employed.

Early consultation with the die caster can often result in production economies in the treatment of metal extension removal.

Guidelines to Extent of Removal

The table below provides a guide to the types of die casting metal extension (flash) which occurs in typical die castings and the amount of metal extension material which remains after (1) degating (removal of any gates and runners from the casting), and (2) commercial trimming of die casting metal extension.

Note that in some instances, where special surface finish characteristics are not involved, the most economic method of degating and metal extension (flash) removal may include a tumbling or vibratory deburring operation.

Guide to Nominal Metal Remaining by Type of Extension

Operation Description	Type of Metal Extension and Nominal Amount Remaining After Degating and Trimming				
	Thick Gates & Overflows > 0.12" (3.0 mm)	Thin Gates & Overflows ≤ 0.12" (3.0 mm)	Parting Line and Seam Line Metal Extension	Metal Extension in Cored Holes	Sharp Corners
After Degating Nominal Flash Remaining	Rough within 0.12" (3.0 mm)	Rough within 0.12" (3.0 mm)	Excess Only Broken Off	Not Removed	Not Removed
After Commercial Trimming* Nominal Extension Remaining	Within 0.06" (1.59 mm)	Within 0.03" (0.8 mm)	Within 0.015" (0.38 mm)	Removed within 0.010" (0.25 mm)**	Not Removed

* "Commercially trimmed" does not include additional operations to remove loose material. For very heavy gates and overflows, consult your die caster.

** Shave trimming may be available to reduce amount of metal remaining in cored holes. Consult your die caster to determine what options are available.

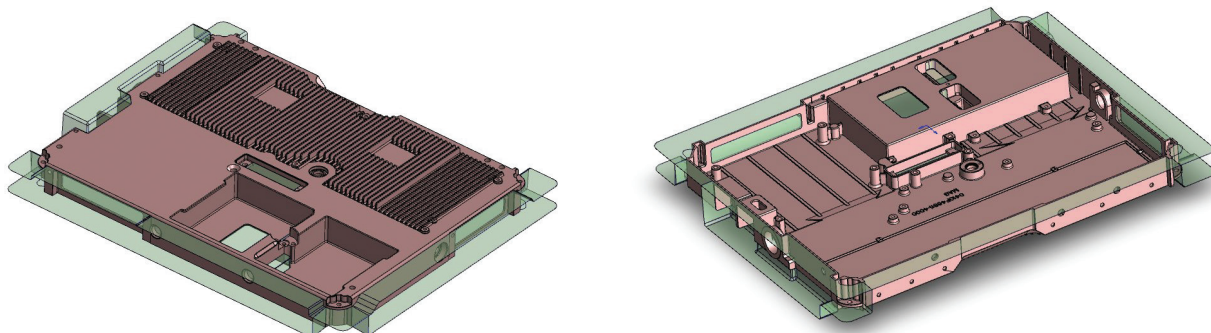

Figure 6-1: Examples of complex parting lines that can make flash extension removal more difficult.

The guidelines for removal of die casting metal extension (flash) presented here represent normal production practice at the most economic level. Precision flash trimming, closer than standard commercial trimming, or the complete removal of all extension involves additional operations and should be specified only when requirements justify the additional cost.

Engineering & Design: Additional Specification Guidelines

The as-cast external surface finish classifications shown here illustrate variations in production practice. Surface finish requirements should be specified for production at the most economic level. Generally, extra steps in die design, die construction and casting production are required for the more exacting finishes, and additional cost may be involved. Selection of the lowest classification number, commensurate with the die cast part application, will yield the lowest cost.

6 Surface Finish, As-Cast

General Guidelines for As Cast Surface Finish on Die Cast Parts

The specification of external surface finish requirements is desirable for selected die casting applications and, in the case of some decorative parts, essential.

The purpose of the guidelines presented here is to classify as-cast surface finish for die castings into a series of grades so that the type of as-cast finish required may be addressed and defined in advance of die design.

These guidelines should be used for general type classification only, with final surface finish quality requirements specifically agreed upon between the die caster and the customer.

The first four classes listed relate to cosmetic surfaces. Class five relates to selected surface areas where specified surface finish limitations are required.

As-Cast Surface Finish Classifications and Final Finish or End Use

Class	As-Cast Finish	Final Finish or End Use
1 Utility Grade	No cosmetic requirements. Surface imperfections (cold shut, rubs, surface porosity, lubricant build-up, etc.) are acceptable	Used as-cast or with protective coatings; Anodize (non-decorative) Chromate (yellow, clear)
2 Functional Grade	Surface imperfections (cold shut, rubs, surface porosity, etc.), that can be removed by spot polishing or can be covered by heavy paint, are acceptable.	Decorative Coatings: Lacquers Enamels Plating (Al) Chemical Finish Polished Finish
3 Commercial Grade	Slight surface imperfections that can be removed by agreed upon means are acceptable.	Structural Parts (high stress areas) Plating (Zn) Electrostatic Painting Transparent Paints
4 Consumer Grade	No objectionable surface imperfections. Where surface waviness (flatness), noted by light reflection, is a reason for rejection special agreement should be reached with the die caster.	Special Decorative Parts
5 Superior Grade	Surface finish, applicable to limited areas of the casting and dependent on alloy selected, to have a maximum value in micro inches as specified on print.	O-Ring Seats or Gasket Areas

NOTE:

As-cast surface finish classification does not apply to machined surfaces. Finished machined surface requirements shall be as agreed upon between the die caster and customer and separately identified on the engineering part drawing.

Typical As-Cast Surface Roughness Guide

Alloy Family / Alloy	Typical Surface Roughness (μ-inches)	
	Expected in a New Die	Over the Life of a Die
Aluminum, ZA-12, ZA-27	63 or better	100-125
Magnesium	63 or better	63 should be maintainable
Zinc, ZA-8	32 or better	63 should be maintainable

Notes:

1. Part design, gate location, draft, flow lines, die surface treatments and other factors can impact surface roughness.
2. Roughness values for Over the Life of a Die do not include heat checking in the die.
3. Die lubricants utilized for special applications may impact surface roughness and the values in the table may not be achievable.

Engineering & Design: Additional Specification Guidelines

Coatings for Castings

	Coating	Applicable Material	Advantages	Price
PRETREATMENTS	A lodine 5200	Al, Mg	1, 2, 3	Low
	Chromate (Class 1A & 3)	Al, Zn	1, 2, 3, 4	Low
	Iron Phosphate	Al, Mg, Zn	1, 3	Low
	NH 35	Mg	1, 2, 3	Low
PRIMERS	Urethane	Al, Mg, Zn	1, 3, 5	Medium
	Epoxy	Al, Mg, Zn	1, 2, 3, 6	Medium
	Zinc Rich	Al, Mg, Zn	1, 2, 3, 6	High
	Zinc Chromate	Al, Mg, Zn	1, 2, 3, 5, 6	Medium
	Vinyl Acid Wash	Al	1, 2, 3, 5	Low
LIQUID TOPCOATS	E-Coat	Al, Mg, Zn	1, 2, 3, 6	Low
	Urethane	Al, Mg, Zn	1, 3, 5, 6, 7	Medium
	Epoxy	Al, Mg, Zn	1, 2, 3, 6	Medium
	Acrylic	Al, Mg, Zn	1, 3, 5, 6, 7	Medium
	Waterbase	Al, Mg, Zn	1, 2, 3, 5, 6, 7	Medium
	Fluropons/ Architect	Al, Mg, Zn	1, 2, 3, 5, 6, 7	High
	Polyester	Al, Mg, Zn	3, 5	Low
	TGIC	Al, Mg, Zn	1, 2, 3, 5, 7	Medium
	Urethane	Al, Mg, Zn	3, 5, 7	Low
	Epoxy	Al, Mg, Zn	1, 2, 3	Medium
POWDER COATS	Hybrid	Al, Mg, Zn	1, 2, 3	Medium
	A nodize	Al*, Mg	1, 2, 3, 5, 6, 7	Low
	Hardcoat - Hard Anodizing	Al, Mg	1, 2, 3, 6, 7	Medium
ELECTROPLATING	Copper	Al, Mg, Zn	1, 2, 4, 6, 8	High
	Copper/Nickel	Al, Mg, Zn	1, 2, 4, 6, 8	High
	Cu/Ni/Chrome	Al, Mg, Zn	1, 2, 4, 6, 8	High
	Brass	Al, Zn	1, 2, 4, 6, 8	High
	Bronze	Al, Zn	1, 2, 4, 6, 8	High
	Zinc	Al, Zn	1, 2, 4, 6, 8	High
	Silver	Al, Zn	1, 2, 4, 6, 8	Very High
	Gold	Al, Zn	1, 2, 4, 6, 8	Very High
ELECTROLESS PLATING	Electroless Nickel	Al, Mg, Zn	1, 2, 3, 4, 6, 8	High
	Electroless Copper	Al, Mg, Zn	1, 2, 3, 4, 6, 8	High

Legend for Advantages:

- 1 Corrosion protection
- 2 Chemical resistance
- 3 Adhesion enhancement
- 4 Conductivity
- 5 Flexibility
- 6 Hardness/ wear resistance/ durability/ mar resistance
- 7 UV resistance
- 8 Decorative finish

* Anodizing of aluminum is contingent upon the specific alloy and may not yield an aesthetically pleasing surface.

For more details contact a viable coating source.

Note: Not all die castings readily accept electro-coatings. Vacuum plating films such as PVD and CVD coatings, mechanical plating such as Zinc/Tin, and thermal spray coatings may also be applied. Consult with the applicable coating suppliers.

Engineering & Design: Additional Specification Guidelines

The guidelines presented here for incorporating logos, lettering and ornamentation in a die cast part represent normal production practices at the most economic level. Fine detail in lettering and art styles can be achieved but may involve additional costs.

7 Die Cast Lettering and Ornamentation

Lettering, medallions, logotypes, trademarks and a range of identification symbols may be reproduced on the surfaces of die cast parts.

Such as-cast ornamentation may be raised or depressed, but note that raised lettering will result in lower die construction costs and reduced die maintenance over the life of the die.

Raised lettering on a depressed panel can be an economical substitute for depressed letters, as shown in the illustration below.

Cast-in Lettering/Ornamentation Guidelines

In addition to the avoidance of depressed lettering or symbols in the casting surface, the following guidelines will achieve the most satisfactory results. The terms used refer to the illustrations below.

1. The Line Thickness (or "face") of any letter to be clearly cast should be 0.010 in. (0.254 mm) or greater.
2. The Height (or raised dimension) of a cast letter or symbol should be equal to or less than the line thickness.
3. The Draft Angle should be greater than 10°.
4. Letters or symbols containing fine serifs or delicate lines cannot be expected to die cast cleanly.

Sample Letter or Symbol

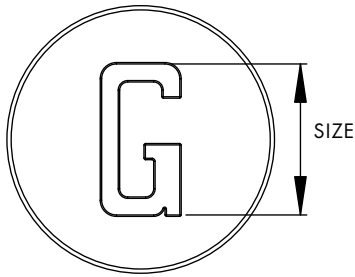

Three Alternative Die Cast Effects

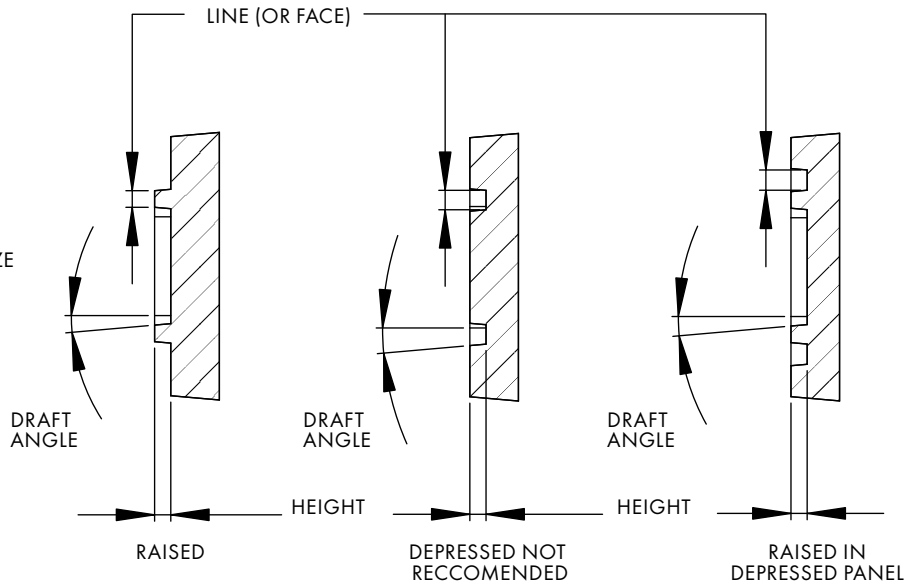

Fig. 1a

Fig. 2a

Fig. 2a

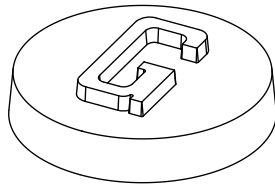

Fig. 1b

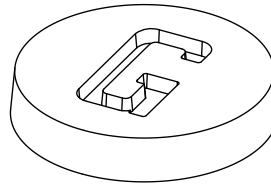

Fig. 2b

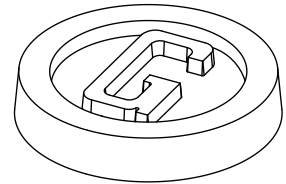

Fig. 2b